

# ANRIN

LEADING WATER

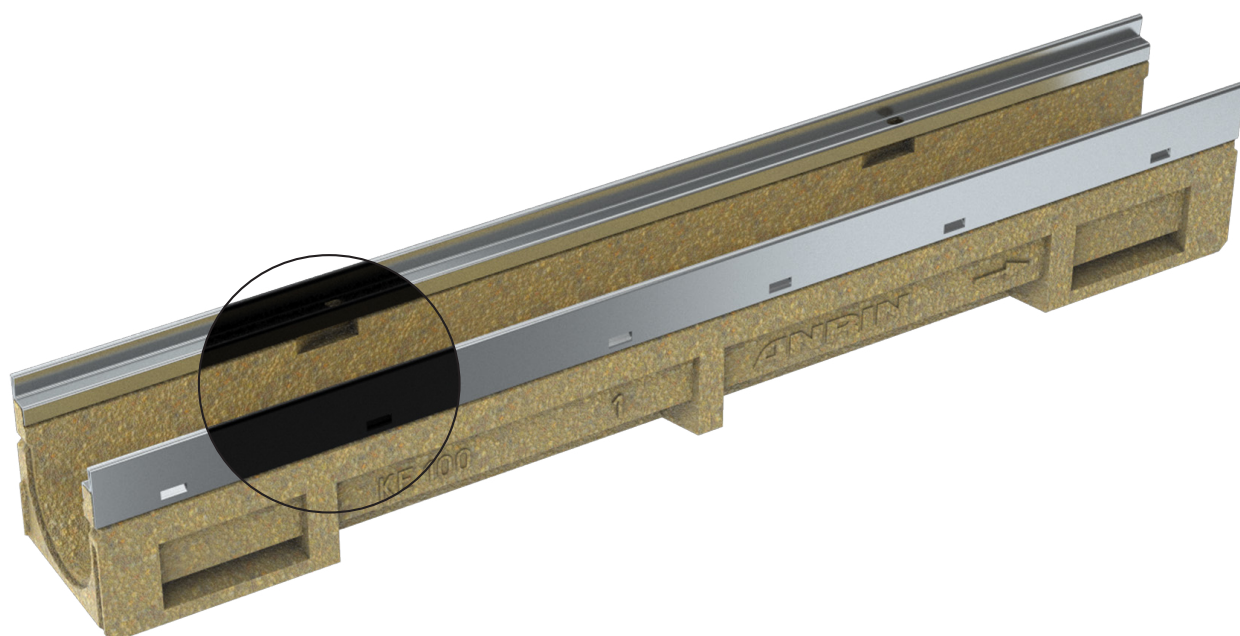

## Technical data sheet

Reinforced edge channels  
KE-100

# Technical data sheet

## Reinforced edge channels KE-100

Channel drainage for the load classes A 15 to E 600

According to DIN 19580 / EN 1433 "Drainage channels for vehicular and pedestrian areas", these surfaces are as-signed to specific load classes depending on the use. Accordingly, the respective suitable ANRIN reinforced edge system can be selected with the corresponding cover grating.

## Product specifications

Product specifications	
Material	Resin concrete
Length	50 cm and 100 cm
Width	13.6 cm
Height	6.0 cm, 8.0 cm, 10.0 cm, 15.0 - 25.0 cm
Weight	9.5 - 25.5 kg
Edge type	Steel edge rail, 6 mm edge width; galvanised, stainless steel or cataphoretic dip-coated in black
Nominal width	100 mm
Load class	A15 to E600*
Slope type	Slope invert 0.5 %, Stepped invert, Constant invert
Joint type	UNILINK®-joint
Fastening	TwistLock fastening

## Material properties

Channel / component body	
Polymer concrete	polyester resin-based with mineral aggregates, additives
Compressive strength	≥ 90 N/mm <sup>2</sup>
Bending tensile strength	≥ 22 N/mm <sup>2</sup>
Modulus of elasticity	ca. 25 kN/mm <sup>2</sup>
Density	2.1 – 2.3 g/dm <sup>3</sup>
Heat resistance	100° C (permanent loading)
Frost resistance	- 50° C
Water penetration depth	0 mm
Water absorption	0.05 %
Edge protection	
Edge protection	Galvanised steel, stainless steel, profile thickness 6 mm or cataphoretic dip-coated in black
Channel cover	
Channel cover	Galvanised steel, V2A stainless steel, GJS cast-iron, PA plastic

# Technical data sheet

## Reinforced edge channels

### Slope types

Area drainage with channel runs is normally made according to 3 different principles. The slope of water surface is achieved by the natural fall of the land. The water flows downwards with the gradient of the water level. A stepped invert is realised by an artificial gradient which is formed by the installation of stepped-height channels and connectors. The high flow rate with self-cleaning effect can be achieved with channels in natural slope.

All slope types can be combined according to hydraulic requirements and topographical conditions.

### Stepped invert

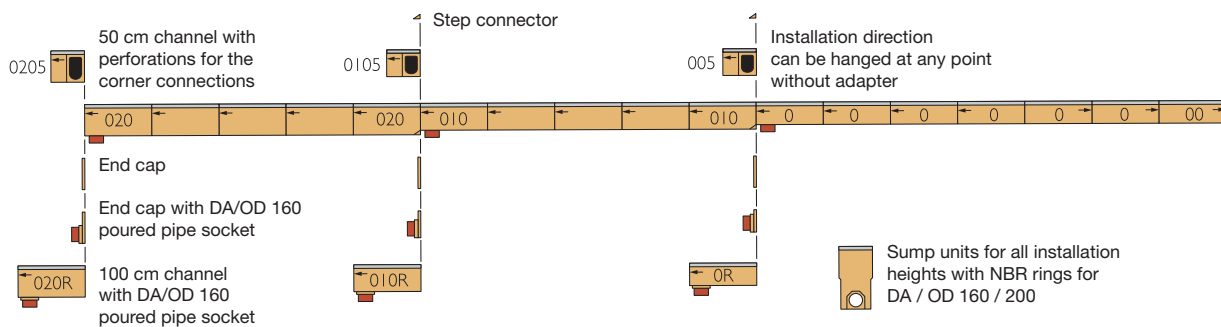

### Constant invert

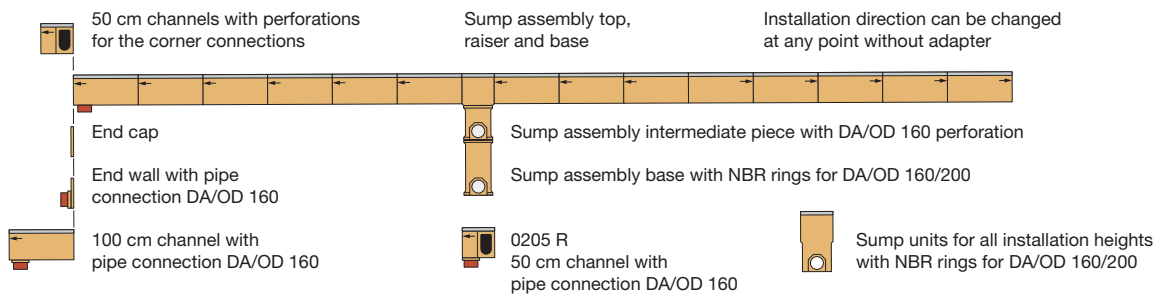

### Slope invert

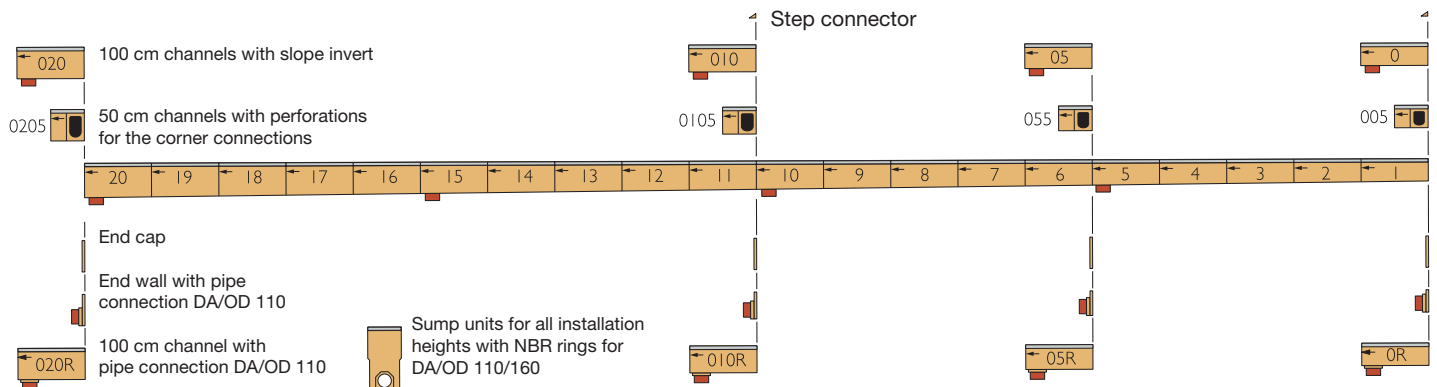

# Technical data sheet

## ANRIN DRAIN Reinforced edge channels KE-100

### Channel dimensions

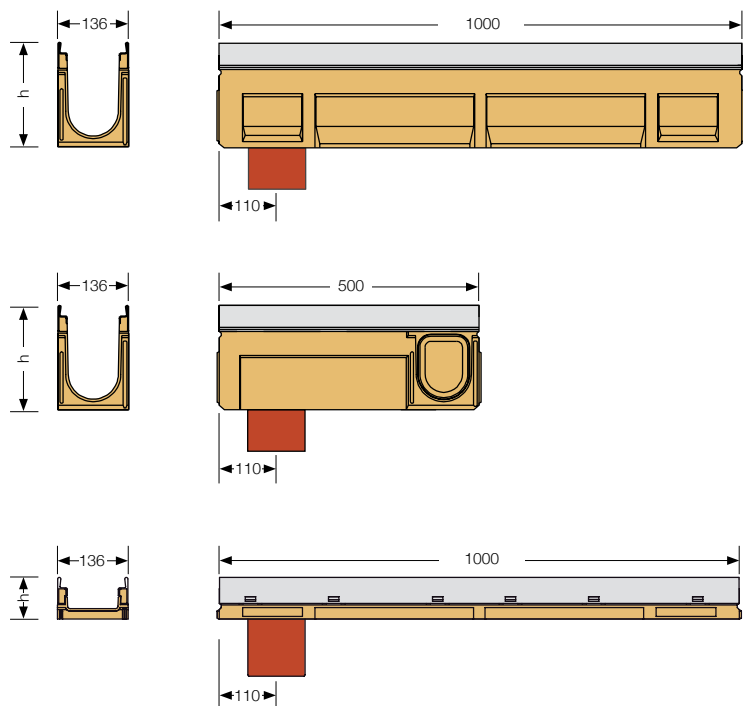

### Accessories dimensions

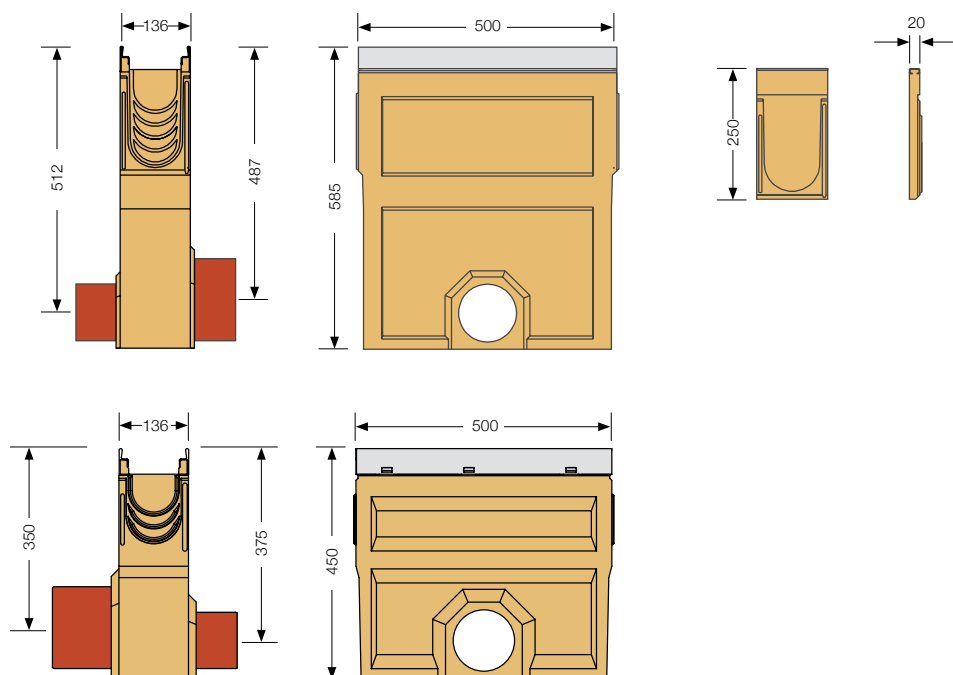

# Technical data sheet

## ANRIN DRAIN Reinforced edge channels KE-100

### Channel types - KE-100 with galvanised steel edge rail

Artikel Nr.	EAN	Beschreibung		Gefälle %	Länge cm	Breite cm	Höhe cm	Gewicht kg
01100000	4026857011057	KE-100 Channel No.	0*	0	100	13.6	15.0	17.5
01100410	4026857011262	KE-100 Channel No.	0R***	0	100	13.6	15.0	17.5
01100450	4026857011279	KE-100 Channel No.	005**/*	0	50	13.6	15.0	9.5
01100010	4026857011064	KE-100 Channel No.	1	0.5	100	13.6	15.5	17.5
01100020	4026857011071	KE-100 Channel No.	2	0.5	100	13.6	16.0	17.5
01100030	4026857011088	KE-100 Channel No.	3	0.5	100	13.6	16.5	18
01100040	4026857011095	KE-100 Channel No.	4	0.5	100	13.6	17.0	18
01100050	4026857011101	KE-100 Channel No.	5*	0.5	100	13.6	17.5	18.5
01100500	4026857011286	KE-100 Channel No.	05*	0	100	13.6	17.5	18.5
01100510	4026857011293	KE-100 Channel No.	05R***	0	100	13.6	17.5	18.5
01100550	4026857011309	KE-100 Channel No.	055**/*	0	50	13.6	17.5	9.5
01100060	4026857011118	KE-100 Channel No.	6	0.5	100	13.6	18.0	19
01100070	4026857011125	KE-100 Channel No.	7	0.5	100	13.6	18.5	19.5
01100080	4026857011132	KE-100 Channel No.	8	0.5	100	13.6	19.0	19.5
01100090	4026857011149	KE-100 Channel No.	9	0.5	100	13.6	19.5	20
01100100	4026857011156	KE-100 Channel No.	10*	0.5	100	13.6	20.0	21
01101000	4026857011316	KE-100 Channel No.	010*	0	100	13.6	20.0	21
01101010	4026857011323	KE-100 Channel No.	010R***	0	100	13.6	20.0	21
01101050	4026857011330	KE-100 Channel No.	0105**/*	0	50	13.6	20.0	10.5
01100110	4026857011163	KE-100 Channel No.	11	0.5	100	13.6	20.5	20.5
01100120	4026857011170	KE-100 Channel No.	12	0.5	100	13.6	21.0	21
01100130	4026857011187	KE-100 Channel No.	13	0.5	100	13.6	21.5	21.5
01100140	4026857011194	KE-100 Channel No.	14	0.5	100	13.6	22.0	21.5
01100150	4026857011200	KE-100 Channel No.	15*	0.5	100	13.6	22.5	22.5
01100160	4026857011217	KE-100 Channel No.	16	0.5	100	13.6	23.0	23
01100170	4026857011224	KE-100 Channel No.	17	0.5	100	13.6	23.5	23
01100180	4026857011231	KE-100 Channel No.	18	0.5	100	13.6	24.0	23.5
01100190	4026857011248	KE-100 Channel No.	19	0.5	100	13.6	24.5	24
01100200	4026857011255	KE-100 Channel No.	20*	0.5	100	13.6	25.0	24.5
01102000	4026857011347	KE-100 Channel No.	020*	0	100	13.6	25.0	25.5
01102010	4026857011354	KE-100 Channel No.	020R***	0	100	13.6	25.0	25.5
01102050	4026857011361	KE-100 Channel No.	0205**/*	0	50	13.6	25.0	11.2
01104060	4026857023777	KE-100 Channel No.	060*	0	100	13.6	6.0	13.1
01104090	4026857023784	KE-100 Channel No.	060R***	0	100	13.6	6.0	13.1
01103080	4026857011385	KE-100 Channel No.	080*	0	100	13.6	8.0	13.3
01103090	4026857012887	KE-100 Channel No.	080R***	0	100	13.6	8.0	13.3
01103000	4026857011378	KE-100 Channel No.	0100*	0	100	13.6	10.0	14.4
01103010	4026857012894	KE-100 Channel No.	0100R***	0	100	13.6	10.0	14.4

\* Channel with mouldings for vertical outlet DA/OD 110

\*\* Channel with sidewise perforations for the connection of t-junctions, elbow joints and cross- over joints and vertical outlet

\*\*\* Channel with vertical pipe socket DA/OD 110

# Technical data sheet

## ANRIN DRAIN Reinforced edge channels KE-100

### Accessories - KE-100 with galvanised steel edge rail

Article no.	EAN	Designation		Length cm	Width cm	Height cm	Weight kg
01106000	4026857011392	KE-100 Sump unit with galvanised mud bucket		50	13.6	58.5	38.5
01106010	4026857020196	KE-100 Sump unit low height for channels up to No.10		50	13.6	45	21.8
01106030	4026857024644	KE-100 Sump unit low height with special DN 110 connection & PE bucket		50	13.6	45	
01006800	4026857000549	Pipe socket DA/OD 110					0.2
01006810	4026857000556	Pipe socket DA/OD 150					0.6
01107000	4026857011408	KE-100 Closed end cap for channel No.	0 bis 0205				1.6
01107400	4026857023791	KE-100 Closed end cap for channel No.	060				1.9
01107800	4026857011446	KE-100 Closed end cap for channel No.	080				1.0
01107900	4026857011453	KE-100 Closed end cap for No.	0100				1.2
01108000	4026857011460	KE-100 end cap with pipe socket DA/OD 110 for channel No.	0				1.0
01108050	4026857011477	KE-100 end cap with pipe socket DA/OD 110 for channel No.	5, 05				1.1
01108100	4026857011484	KE-100 end cap with pipe socket DA/OD 110 for channel No.	10, 010				1.2
01108200	4026857011491	KE-100 end cap with pipe socket DA/OD 110 for channel No.	20, 020				1.4
01108800	4026857020141	KE-100 end cap with pipe socket DA/OD 50 for channel No.	080				0.4
01108900	4026857019244	KE-100 end cap with pipe socket DA/OD 50 for channel No.	0100				0.4
01107500	4026857011415	KE-100 Step connector for compensating level differences					0.5
01006600	4026857000525	Odour trap made from PVC DN 100					
01006610	4026857000532	Odour trap made from PVC DN 150					
01006700	4026857026594	Odour trap with leaf screen					

# Technical data sheet

## ANRIN DRAIN Reinforced edge channels KE-100

### Channel types - KE-100 with stainless steel edge rail

Article no.	EAN	Designation		Slope %	Length cm	Width cm	Height cm	Weight kg
01400000	4026857018193	KE-100 Channel No.	0*	0	100	13.6	15.0	17.5
01400410	4026857018407	KE-100 Channel No.	0R***	0	100	13.6	15.0	17.5
01400450	4026857018414	KE-100 Channel No.	005**/*	0	50	13.6	15.0	9.5
01400010	4026857018209	KE-100 Channel No.	1	0.5	100	13.6	15.5	17.5
01400020	4026857018216	KE-100 Channel No.	2	0.5	100	13.6	16.0	17.5
01400030	4026857018223	KE-100 Channel No.	3	0.5	100	13.6	16.5	18.0
01400040	4026857018230	KE-100 Channel No.	4	0.5	100	13.6	17.0	18.0
01400050	4026857018247	KE-100 Channel No.	5*	0.5	100	13.6	17.5	18.5
01400500	4026857018421	KE-100 Channel No.	05*	0	100	13.6	17.5	18.5
01400510	4026857018438	KE-100 Channel No.	05R***	0	100	13.6	17.5	18.5
01400550	4026857018445	KE-100 Channel No.	055**/*	0	50	13.6	17.5	9.5
01400060	4026857018254	KE-100 Channel No.	6	0.5	100	13.6	18.0	19.0
01400070	4026857018261	KE-100 Channel No.	7	0.5	100	13.6	18.5	19.5
01400080	4026857018278	KE-100 Channel No.	8	0.5	100	13.6	19.0	19.5
01400090	4026857018285	KE-100 Channel No.	9	0.5	100	13.6	19.5	20.0
01400100	4026857018292	KE-100 Channel No.	10*	0.5	100	13.6	20.0	21.0
01401000	4026857018452	KE-100 Channel No.	010*	0	100	13.6	20.0	21.0
01401010	4026857018469	KE-100 Channel No.	010R***	0	100	13.6	20.0	21.0
01401050	4026857018476	KE-100 Channel No.	0105**/*	0	50	13.6	20.0	10.5
01400110	4026857018308	KE-100 Channel No.	11	0.5	100	13.6	20.5	20.5
01400120	4026857018315	KE-100 Channel No.	12	0.5	100	13.6	21.0	21.0
01400130	4026857018322	KE-100 Channel No.	13	0.5	100	13.6	21.5	21.5
01400140	4026857018339	KE-100 Channel No.	14	0.5	100	13.6	22.0	22.0
01400150	4026857018346	KE-100 Channel No.	15*	0.5	100	13.6	22.5	22.5
01400160	4026857018353	KE-100 Channel No.	16	0.5	100	13.6	23.0	23.0
01400170	4026857018360	KE-100 Channel No.	17	0.5	100	13.6	23.5	23.0
01400180	4026857018377	KE-100 Channel No.	18	0.5	100	13.6	24.0	23.5
01400190	4026857018384	KE-100 Channel No.	19	0.5	100	13.6	24.5	24.0
01400200	4026857018391	KE-100 Channel No.	20*	0.5	100	13.6	25.0	24.5
01402000	4026857018490	KE-100 Channel No.	020*	0	100	13.6	25.0	25.5
01402010	4026857019145	KE-100 Channel No.	020R***	0	100	13.6	25.0	25.5
01402050	4026857018506	KE-100 Channel No.	0205**/*	0	50	13.6	25.0	11.2
01404060	4026857023807	KE-100 Channel No.	060*	0	100	13.6	6.0	13.1
01404090	4026857025061	KE-100 Channel No.	060R***	0	100	13.6	6.0	13.1
01403080	4026857018537	KE-100 Channel No.	080*	0	100	13.6	8.0	13.3
01403090	4026857018544	KE-100 Channel No.	080R***	0	100	13.6	8.0	13.3
01403000	4026857018513	KE-100 Channel No.	0100*	0	100	13.6	10.0	14.4
01403010	4026857018520	KE-100 Channel No.	0100R***	0	100	13.6	10.0	14.4

\* Channel with mouldings for vertical outlet DA/OD 110

\*\* Channel with sidewise perforations for the connection of t-junctions, elbow joints and cross- over joints and vertical outlet

\*\*\* Channel with vertical pipe socket DA/OD 110

# Technical data sheet

## ANRIN DRAIN Reinforced edge channels KE-100

### Accessories – KE-100 with stainless steel edge rail

Article no.	EAN	Designation		Length cm	Width cm	Height cm	Weight kg
01406000	4026857018551	KE-100 Sump unit with galvanised mud bucket		50	13.6	58.5	38.5
01406010	4026857020202	KE-100 Sump unit low height for channels up to No.	10	50	13.6	45	21.8
01006800	4026857000549	Pipe socket DA/OD 110					0.2
01006810	4026857000556	Pipe socket DA/OD 150					0.6
01407000	4026857018568	KE-100 Closed end cap for channel No.	0-0205				1.6
01407400	4026857023821	KE-100 Closed end cap for channel No.	060				1.9
01407800	4026857018575	KE-100 Closed end cap for channel No.	080				1.0
01407900	4026857018582	KE-100 Closed end cap for channel No.	0100				1.2
01408000	4026857018599	KE-100 end cap with pipe socket DA/OD 110 for channel No.	0				1.0
01408050	4026857018605	KE-100 end cap with pipe socket DA/OD 110 for channel No.	5. 05				1.1
01408100	4026857018612	KE-100 end cap with pipe socket DA/OD 110 for channel No.	10, 010				1.2
01408200	4026857018629	KE-100 end cap with pipe socket DA/OD 110 for channel No.	20, 020				1.4
01408800	4026857021049	KE-100 end cap with pipe socket DA/OD 50 for channel No.	080				0.4
01408900	4026857020219	KE-100 end cap with pipe socket DA/OD 50 for channel No.	0100				0.4
01107500	4026857011415	KE-100 Step connector for compensating level differences					0.5
01006600	4026857000525	Odour trap made from PVC DN 100					
01006610	4026857000532	Odour trap made from PVC DN 150					
01006700	4026857026594	Odour trap with leaf screen					



# Technical data sheet

## ANRIN DRAIN Reinforced edge channels KE-100

### Channel types – KE-100 with black cataphoretic dip coated steel edge rail

Article no.	EAN	Designation		Slope %	Length cm	Width cm	Height cm	Weight kg
01500000	4026857024095	KE-100 Channel No.	0*	0	100	13.6	15.0	17.5
01500410	4026857024101	KE-100 Channel No.	0R***	0	100	13.6	15.0	17.5
01500450	4026857024118	KE-100 Channel No.	005**/*	0	50	13.6	15.0	9.5
01500010	4026857024279	KE-100 Channel No.	1	0.5	100	13.6	15.5	17.5
01500020	4026857024286	KE-100 Channel No.	2	0.5	100	13.6	16.0	17.5
01500030	4026857024293	KE-100 Channel No.	3	0.5	100	13.6	16.5	18
01500040	4026857024316	KE-100 Channel No.	4	0.5	100	13.6	17.0	18
01500050	4026857024309	KE-100 Channel No.	5*	0.5	100	13.6	17.5	18.5
01500500	4026857024200	KE-100 Channel No.	05*	0	100	13.6	17.5	18.5
01500510	4026857024217	KE-100 Channel No.	05R***	0	100	13.6	17.5	18.5
01500550	4026857024224	KE-100 Channel No.	055**/*	0	50	13.6	17.5	9.5
01500060	4026857024323	KE-100 Channel No.	6	0.5	100	13.6	18.0	19
01500070	4026857024330	KE-100 Channel No.	7	0.5	100	13.6	18.5	19.5
01500080	4026857024347	KE-100 Channel No.	8	0.5	100	13.6	19.0	19.5
01500090	4026857024354	KE-100 Channel No.	9	0.5	100	13.6	19.5	20
01500100	4026857024361	KE-100 Channel No.	10*	0.5	100	13.6	20.0	21
01501000	4026857024125	KE-100 Channel No.	010*	0	100	13.6	20.0	21
01501010	4026857024132	KE-100 Channel No.	010R***	0	100	13.6	20.0	21
01501050	4026857024163	KE-100 Channel No.	0105**/*	0	50	13.6	20.0	10.5
01500110	4026857024378	KE-100 Channel No.	11	0.5	100	13.6	20.5	20.5
01500120	4026857024385	KE-100 Channel No.	12	0.5	100	13.6	21.0	21
01500130	4026857024392	KE-100 Channel No.	13	0.5	100	13.6	21.5	21.5
01500140	4026857024408	KE-100 Channel No.	14	0.5	100	13.6	22.0	22
01500150	4026857024415	KE-100 Channel No.	15*	0.5	100	13.6	22.5	22.5
01500160	4026857024422	KE-100 Channel No.	16	0.5	100	13.6	23.0	23
01500170	4026857024439	KE-100 Channel No.	17	0.5	100	13.6	23.5	23
01500180	4026857024446	KE-100 Channel No.	18	0.5	100	13.6	24.0	23.5
01500190	4026857024453	KE-100 Channel No.	19	0.5	100	13.6	24.5	24
01500200	4026857024460	KE-100 Channel No.	20*	0.5	100	13.6	25.0	24.5
01502000	4026857024170	KE-100 Channel No.	020*	0	100	13.6	25.0	25.5
01502010	4026857024187	KE-100 Channel No.	020R***	0	100	13.6	25.0	25.5
01502050	4026857024194	KE-100 Channel No.	0205**/*	0	50	13.6	25.0	11.2
01504060	4026857024231	KE-100 Channel No.	060*	0	100	13.6	6.0	13.1
01504090	4026857024248	KE-100 Channel No.	060R***	0	100	13.6	6.0	13.1
01503080	4026857024255	KE-100 Channel No.	080*	0	100	13.6	8.0	13.3
01503090	4026857024262	KE-100 Channel No.	080R***	0	100	13.6	8.0	13.3
01503000	4026857024149	KE-100 Channel No.	0100*	0	100	13.6	10.0	14.4
01503010	4026857024156	KE-100 Channel No.	0100R***	0	100	13.6	10.0	14.4

\* Channel with mouldings for vertical outlet DA/OD 110

\*\* Channel with sidewise perforations for the connection of t-junctions, elbow joints and cross- over joints and vertical outlet

\*\*\* Channel with vertical pipe socket DA/OD 110

# Technical data sheet

## ANRIN DRAIN Reinforced edge channels KE-100

### Accessories – KE-100 with black cataphoretic dip coated steel edge rail

Article no.	EAN	Designation		Length cm	Width cm	Height cm	Weight kg
01506000	4026857024477	KE-100 Sump unit with galvanised mud bucket		50	13.6	58.5	38.5
01506010	4026857024484	KE-100 Sump unit low height for channels up to No.	10	50	13.6	45	21.8
01006800	4026857000549	Pipe socket DA/OD 110					0.2
01006810	4026857000556	Pipe socket DA/OD 150					0.6
01507000	4026857024491	KE-100 Closed end cap for channel No.	0-0205				1.6
01507400	4026857024507	KE-100 Closed end cap for channel No.	060				1.9
01507800	4026857024514	KE-100 Closed end cap for channel No.	080				1.0
01507900	4026857024521	KE-100 Closed end cap for channel No.	0100				1.2
01508000	4026857024538	KE-100 end cap with pipe socket DA/OD 110 for channel No.	0				1.0
01508050	4026857024545	KE-100 end cap with pipe socket DA/OD 110 for channel No.	5, 05				1.1
01508100	4026857024552	KE-100 end cap with pipe socket DA/OD 110 for channel No.	10, 010				1.2
01508200	4026857024569	KE-100 end cap with pipe socket DA/OD 110 for channel No.	20, 020				1.4
01508800	4026857024576	KE-100 end cap with pipe socket DA/OD 50 for channel No.	080				0.4
01508900	4026857024583	KE-100 end cap with pipe socket DA/OD 50 for channel No.	0100				0.4
01107500	4026857011415	KE-100 Step connector for compensating level differences					0.5
01006600	4026857000525	Odour trap made from PVC DN 100					
01006610	4026857000532	Odour trap made from PVC DN 150					
01006700	4026857026594	Odour trap with leaf screen					

# Technical data sheet

## ANRIN DRAIN Reinforced edge channels KE-100

### Cover gratings – KE-100



Slotted plastic grating Oval Grip Design

plastic (grey)  
Length: 50 cm,  
SW 8 mm

Load classes:  
**B125**

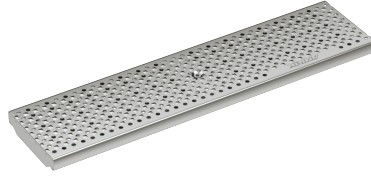

Perforated grating

steel (galvanised), stainless  
Length: 50 cm, 100 cm,  
MW 25 x 10 mm,  
Ø 6 mm

Load classes:  
**A15, C250**



Double slotted steel grating

steel (galvanised), stainless  
Length: 50 cm, 100 cm,  
SW 10 mm,

Load classes:  
**A15, C250**



Slotted plastic grating Oval Grip Design

plastic (black)  
Length: 50 cm,  
SW 8 mm

Load classes:  
**C250**



Slotted grating SW 10

cast iron (coated in black)  
Length: 50 cm,  
SW 10 mm

Load classes:  
**C250**



Design grating CELTIC

cast iron (uncoated)  
Length: 50 cm,  
SW 10 mm,

Load classes:  
**C250**



Design grating, LEAF

cast iron (uncoated)  
Length: 50 cm,  
SW 5 - 9 mm

Load classes:  
**C250**



Mesh grating

steel (galvanised), stainless  
Length: 50 cm, 100 cm  
MW 30 x 14 mm

Load classes:  
**B125, C250**



Longitudinal profile grating

stainless steel  
Length: 50 cm, 100 cm  
SW 5 mm

Load classes:  
**B125, D400\***

\* Exception: Cross-road drainage of busy roads SW = slot width / MW = mesh width

# Technisches Datenblatt

## ANRIN DRAIN Kantenschutzrinnen KE-100

### Cover gratings – KE-100



Slotted grating HEELGUARD

cast iron (coated in black)  
Length: 50 cm,  
SW 6 mm  
Load classes:  
**D400\***



Longitudinal-bar grating

cast iron (cataphoretic dip coating)  
Length: 50 cm,  
MW 25 x 10 mm  
Load classes:  
**D400\***



Slotted grating Oval Grip Design

cast iron (cataphoretic dip coating)  
Length: 50 cm,  
SW 10 mm  
Load classes:  
**C250, E600\***

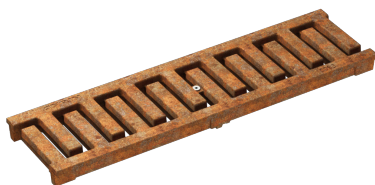

Slotted steel grating MASSIV 32

cast iron (uncoated)  
Length: 50 cm,  
SW 11 mm  
Load classes:  
**E600\***

\* Exception: Cross-road drainage of busy roads SW = slot width / MW = mesh width

# Technical data sheet

## ANRIN DRAIN Reinforced edge channels KE-100

### Cover gratings cl. **A15** with TwistLock fastening

Article no.	EAN	Designation	Length cm	Width cm	Inlet Ø cm <sup>2</sup> /m	Weight kg
01004200	4026857000327	Slotted steel grating, galvanised, SW 10 mm	100	12.3	280	2.4
01004220	4026857000334	Slotted steel grating, galvanised, SW 10 mm	50	12.3	280	1.2
01004300	4026857000358	Slotted steel grating, stainless steel, SW 10 mm	100	12.3	280	2.4
01004320	4026857000365	Slotted steel grating, stainless steel, SW 10 mm	50	12.3	280	1.2
01004440	4026857019084	Perforated grating, galvanised steel	100	12.3	178	1.2
01004460	4026857019091	Perforated grating, galvanised steel	50	12.3	178	0.6
01004441	4026857030492	Perforated grating, stainless steel	100	12.3	178	1.2

### Cover gratings cl. **B125** with TwistLock fastening

Article no.	EAN	Designation	Length cm	Width cm	Inlet Ø cm <sup>2</sup> /m	Weight kg
01004100	4026857000303	Mesh grating, galvanised, MW 30 x 14 mm	100	12.3	870	2.8
01004120	4026857000310	Mesh grating, galvanised, MW 30 x 14 mm	50	12.3	870	1.5
01004250	4026857032601	Longitudinal profile grating, stainless steel, SW 5 mm	100	12.3	532	4.1
01004270	4026857031956	Longitudinal profile grating, stainless steel, SW 5 mm	50	12.3	532	2.1
01004140	4026857021759	Slotted plastic grating, Oval Grip Design, color gray, SW 8 mm	50	12.3	338	1.1

### Cover gratings cl. **C250** with TwistLock fastening

Article no.	EAN	Designation	Length cm	Width cm	Inlet Ø cm <sup>2</sup> /m	Weight kg
01004600	4026857000419	Double slotted steel grating, galvanised steel, SW 10 mm	100	12.3	280	5.0
01004620	4026857000426	Double slotted steel grating, galvanised steel, SW 10 mm	50	12.3	280	2.5
01004640	4026857000433	Double slotted steel grating, stainless steel, SW 10 mm	100	12.3	280	5.0
01004660	4026857000440	Double slotted steel grating, stainless steel, SW 10 mm	50	12.3	280	2.5
01004500	4026857000396	Mesh grating, galvanised steel, MW 30 x 10 mm	100	12.3	770	4.2
01004520	4026857000402	Mesh grating, galvanised steel, MW 30 x 10 mm	50	12.3	770	2.2
01004540	4026857009030	Mesh grating, stainless steel, MW 20 x 14 mm	100	12.3	770	4.2
01004560	4026857009047	Mesh grating, stainless steel, MW 20 x 14 mm	50	12.3	770	2.1
01005020	4026857000495	Slotted cast iron grating, GJS, SW 10 mm	50	12.3	350	5.8
01005060	4026857019121	Slotted cast iron grating, Oval Grip Design, SW 10 mm	50	12.3	420	3,6
01004510	4026857021766	Slotted plastic grating, Oval Grip Design, color black, SW 8 mm	50	12.3	338	1.1
01004700	4026857000457	Perforated grating, galvanised steel	100	12.3	178	4.6
01004720	4026857000464	Perforated grating, galvanised steel	50	12.3	178	2.3
01004740	4026857009054	Perforated grating, stainless steel	100	12.3	178	4.9
01004760	4026857009061	Perforated grating, stainless steel	50	12.3	178	2.4
01004470	4026857029090	Design grating, LEAF, cast iron, uncoated	50	12.3	114	4.1
01004480	4026857029083	Design grating, CELTIC, cast iron, uncoated	50	12.3	222	3.9

# Technical data sheet

## ANRIN DRAIN Reinforced edge channels KE-100

### Cover gratings cl. **D400**<sup>1</sup> with TwistLock fastening

Article no.	EAN	Designation	Length cm	Width cm	Inlet Ø cm <sup>2</sup> /m	Weight kg
01004930	4026857031994	Longitudinal profile grating, stainless steel, SW 5 mm	100	12.3	505	5.2
01004931	4026857032007	Longitudinal profile grating, stainless steel, SW 5 mm	50	12.3	505	2.6
01004900	4026857022459	Mesh grating, galvanised steel, MW 20 x 14 mm	100	12.3	720	5.2
01004920	4026857022442	Mesh grating, galvanised steel, MW 20 x 14 mm	50	12.3	720	2.6
01004940	4026857022466	Mesh grating, stainless steel, MW 20 x 14 mm	100	12.3	720	4.2
01004960	4026857022473	Mesh grating, stainless steel, MW 20 x 14 mm	50	12.3	720	2.7
01004970	4026857026211	Longitudinal-bar grating, GJS, SW 10 mm	50	12.3	420	4.1
01004980	4026857029038	Slotted grating, HEELGUARD, cast iron, coated in black	50	12.3	360	3.8

<sup>1</sup> Exception: Cross-road drainage of busy roads

### Cover gratings cl. **E600**<sup>1</sup> with TwistLock fastening

Article no.	EAN	Designation	Length cm	Width cm	Inlet Ø cm <sup>2</sup> /m	Weight kg
01005120	4026857000501	Slotted cast iron grating, Oval Grip Design, SW 10 mm	50	12.3	420	5.0
01005130	4026857029106	Slotted steel grating, MASSIV 32, cast iron, uncoated	50	12.3	370	5.8

<sup>1</sup> Exception: Cross-road drainage of busy roads

### Cover gratings with TwistLock fastening - Accessories

Article no.	EAN	Designation	Length cm	Width cm	Inlet Ø cm <sup>2</sup> /m	Weight kg
01004230	4026857000341	KE-/KF-/KS-100 TwistLock fastening, single				

# Technical data sheet

## ANRIN DRAIN Reinforced edge channels

### Example installations

The following installation guidelines are schematic representations. These are provided as examples and are non-binding. The information provided here is based on our long-term experience in excavation and road construction as well as the state-of-the-art technology. Despite this, designers and planners are always obligated to check the products and the installation instructions for their appropriateness. The example details are simplified recommendations for execution. Constructions are to be re-created on a project-specific basis.

Important: Insert gratings for the installation.

### Load class A 15

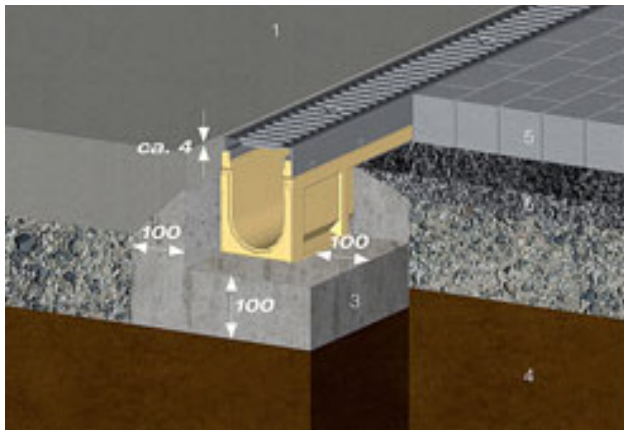

Road concrete and / or concrete sheets or paving bed

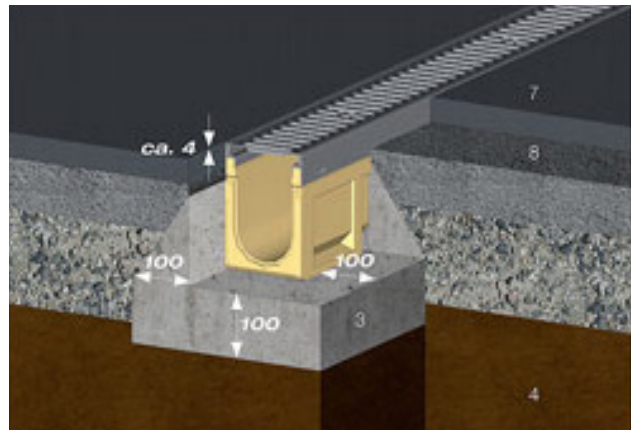

Cast asphalt

### Load class B 125

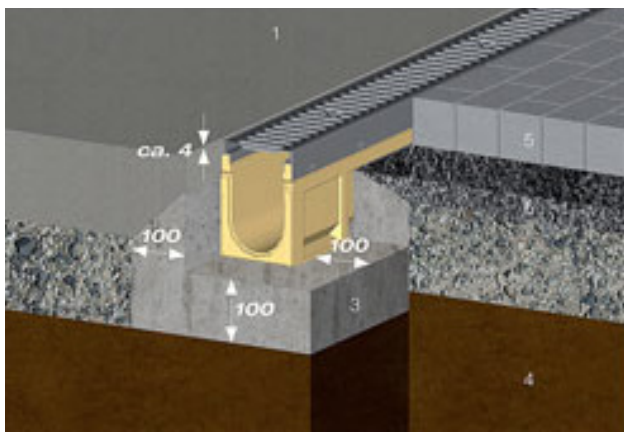

Road concrete and / or concrete sheets or paving bed

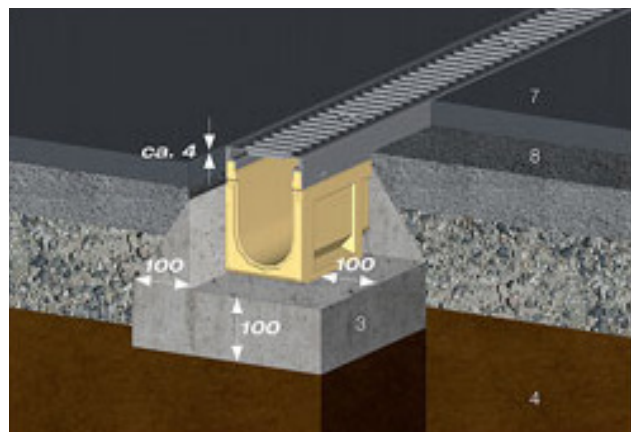

Cast asphalt

- 1 In-situ road concrete
- 2 Base course
- 3 Concrete cladding of the channel body B 25  
Concrete class C12/15 (A 15 – C 250)  
Concrete class C12/25 (D 400 – E 600)
- 4 Foundation, mature soil
- 5 Prefabricated concrete sheets and / or stone systems

- 6 Paving bed
- 7 Wearing course
- 8 Bonding course
- 9 Bitumen base course

All length specifications in millimetres



# Technical data sheet

## ANRIN DRAIN Reinforced edge channels

### Load class **C 250**

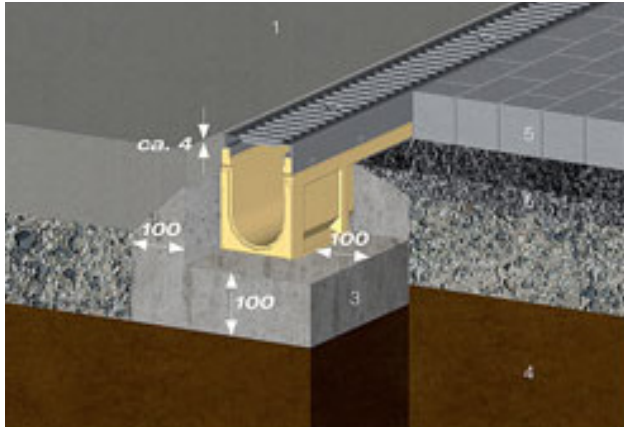

Road concrete and / or concrete sheets or paving bed

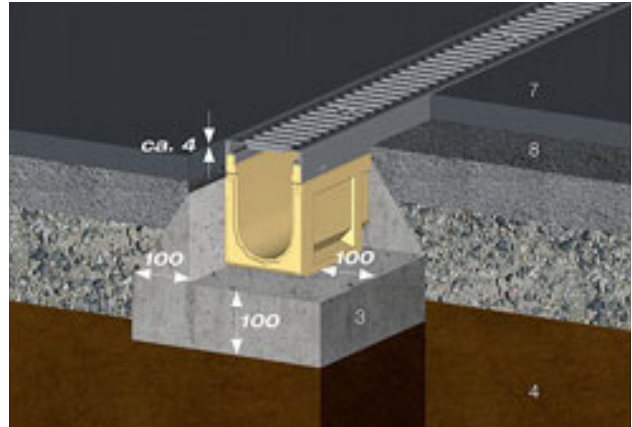

Cast asphalt

### Load class **D 400 – E 600** (Exception: Cross-road drainage of busy roads)

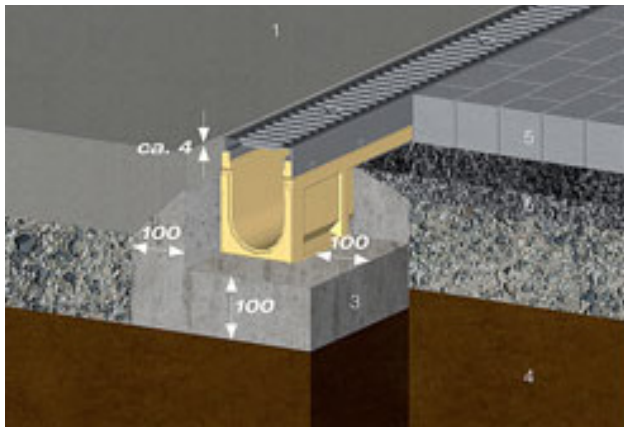

Road concrete and / or concrete sheets or paving bed

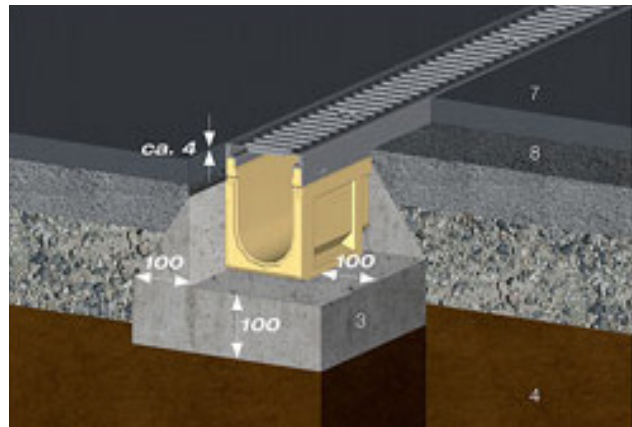

Cast asphalt

- 1 In-situ road concrete
- 2 Base course
- 3 Concrete cladding of the channel body B 25  
Concrete class C12/15 (A 15 – C 250)  
Concrete class C12/25 (D 400 – E 600)
- 4 Foundation, mature soil
- 5 Prefabricated concrete sheets and / or stone systems

- 6 Paving bed
- 7 Wearing course
- 8 Bonding course
- 9 Bitumen base course

All length specifications in millimetres

### Guidelines and regulations

DIN EN 1433	"Drainage channels for vehicular and pedestrian areas"
DIN 19580	"Drainage channels for vehicular and pedestrian areas ..."
RStO	"Guidelines for the standardisation of the superstructure of vehicular areas"
DIN EN 206-1	"Concrete. Specification, performance, production and conformity"
DIN EN 1045-2	"Concrete, reinforced and prestressed concrete structures. Part 2: Concrete – Specification, properties, production and conformity; Application rules for DIN EN 206-1"





ANRIN GmbH  
Siemensstr. 1  
59609 Anröchte  
Germany

+49 (0) 29 47.97 81-0  
[www.anrin.com](http://www.anrin.com)  
[info@anrin.com](mailto:info@anrin.com)